

PRODUCT SHEET

Snap Frame A1 Mitred Corners 32 mm B1 Fire Rated

KRA1G32B1

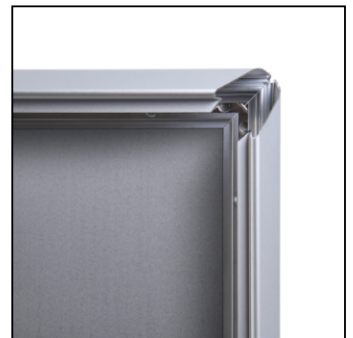

- Snap frame A1 silver anodised profile
- 32 mm stable frame with mitred corners
- B1 certificate thanks to fire resistant metal backwall and poster protection foil

PRODUCT SHEET

Snap Frame A1 Mitred Corners 32 mm B1 Fire Rated

KRA1G32B1

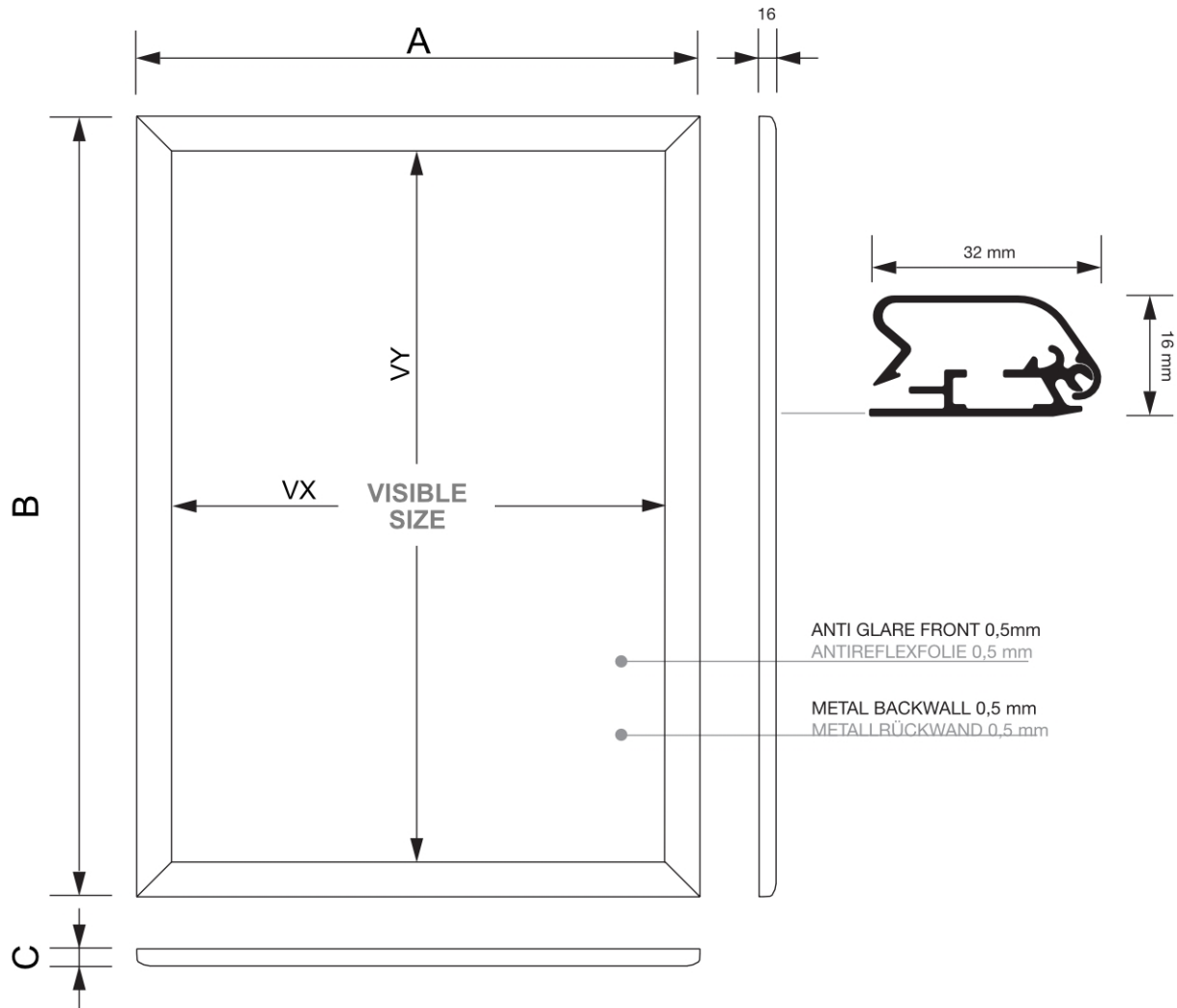

BACK VIEW RÜCKANSICHT

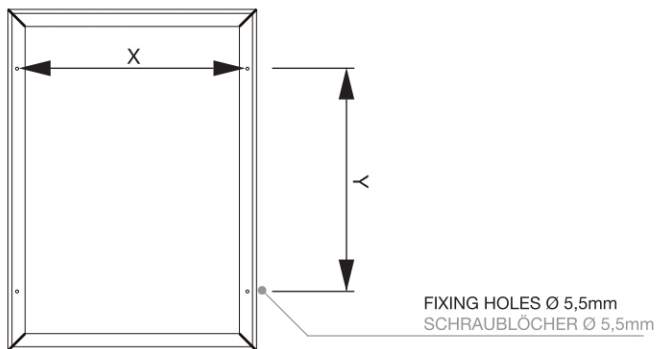

ACCESSORIES ZUBEHÖR



(SOSSET)
SET OF SCREWS
SCHRAUBENSET

(HHKR)
HANGING HOOKS
HAKEN ZUM ABHÄNGEN



PRODUCT SHEET

Snap Frame A1 Mitred Corners 32 mm B1 Fire Rated

KRA1G32B1

GENERAL INFO

SKU	Sizes (mm) (A x B x C)	Format (mm)	Visible size (mm) (VXxVY)	Hole spacing (mm) (XxY)
KRA1G32B1	639 x 886 x 20	A1 (594 x 841 mm)	577 x 824 mm	606 x 581 mm

Orientation	Weight (kg)
Vertical	3,97

PACKAGING INFORMATION

Packaging unit 1 (mm)	Packaging unit 2 (mm)	Packaging unit 3 (mm)
896 x 649 x 30	-	-

Palette number of pieces	Palette weight (kg)	Palette type
66	358	EUR

ADDITIONAL INFORMATION

Product certifications	EAN
DIN4102B1	8595578357523

SIZE GUIDE

Snap Frame A1 Mitred Corners 32 mm B1 Fire Rated

KRA1G32B1

